



CATÁLOGO
Decorativas I



DEC1-1



DEC1-2



DEC1-3



DEC1-4



DEC1-5



DEC1-6



DEC1-7



DEC1-8



DEC1-9



DEC1-10



DEC1-11



DEC1-12



DEC1-13



DEC1-14



DEC1-15



DEC1-16



DEC1-17



DEC1-18



DEC1-19



DEC1-20

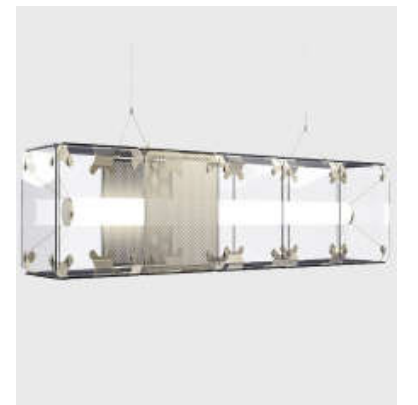

DEC1-21



DEC1-22



DEC1-23



DEC1-24



DEC1-25



DEC1-26

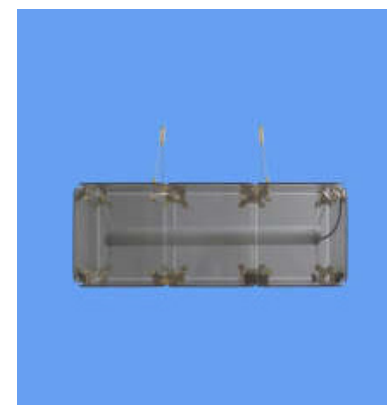

DEC1-27



DEC1-28



DEC1-29



DEC1-30



DEC1-31



DEC1-32



DEC1-33



DEC1-34



DEC1-35



DEC1-36



DEC1-37



DEC1-38



DEC1-39



DEC1-40



DEC1-41



DEC1-42

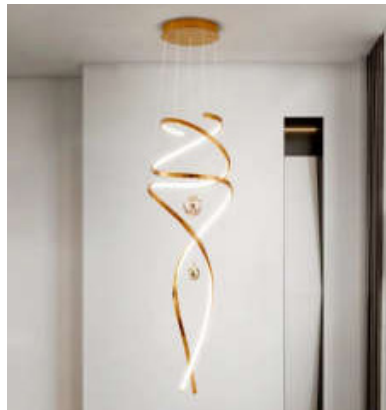

DEC1-43



DEC1-44



DEC1-45



DEC1-46



DEC1-47



DEC1-48



DEC1-49



DEC1-50



DEC1-51



DEC1-52



DEC1-53



DEC1-54



DEC1-55



DEC1-56



DEC1-57



DEC1-58



DEC1-59



DEC1-60



DEC1-61



DEC1-62



DEC1-63



DEC1-64



DEC1-65



DEC1-66



DEC1-67



DEC1-68



DEC1-69



DEC1-70



DEC1-71



DEC1-72



DEC1-73



DEC1-74



DEC1-75



DEC1-76

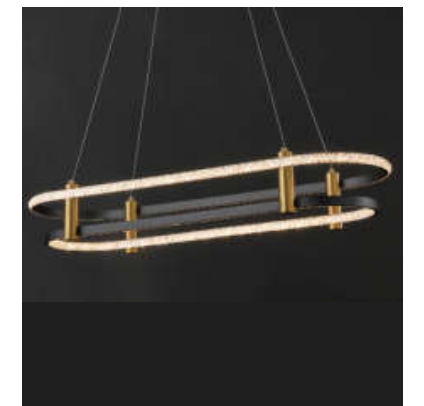

DEC1-77



DEC1-78



DEC1-79



DEC1-80



DEC1-81



DEC1-82



DEC1-83



DEC1-84



DEC1-85



DEC1-86



DEC1-87



DEC1-88



DEC1-89



DEC1-90



DEC1-91



DEC1-92



DEC1-93



DEC1-94



DEC1-95



DEC1-96



DEC1-97



DEC1-98



DEC1-99



DEC1-100



DEC1-101



DEC1-102



DEC1-103



DEC1-104



DEC1-105



DEC1-106



DEC1-107



DEC1-108



DEC1-109

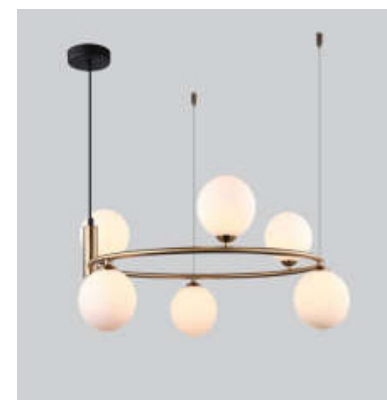

DEC1-110



DEC1-111



DEC1-112



DEC1-113



DEC1-114



DEC1-115



DEC1-116



DEC1-117



DEC1-118



DEC1-119



DEC1-120



DEC1-121



DEC1-122



DEC1-123



DEC1-124



DEC1-125



DEC1-126



DEC1-127



DEC1-128



DEC1-129



DEC1-130

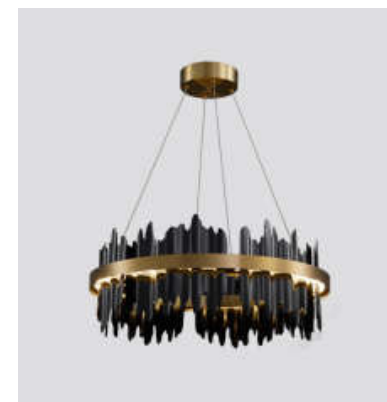

DEC1-131



DEC1-132



DEC1-133



DEC1-134



DEC1-135



DEC1-136

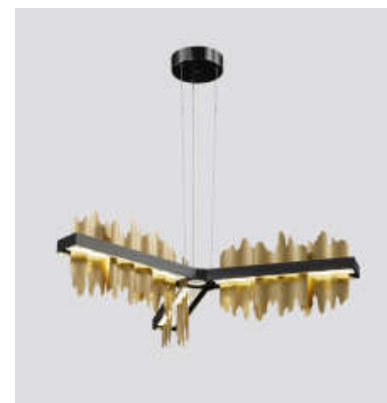

DEC1-137



DEC1-138



DEC1-139

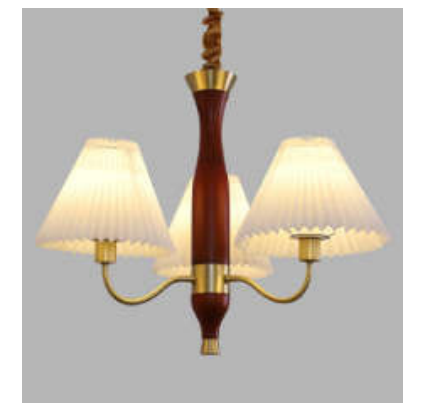

DEC1-140



DEC1-141



DEC1-142



DEC1-143



DEC1-144



DEC1-145



DEC1-146



DEC1-147



DEC1-148



DEC1-149



DEC1-150



DEC1-151



DEC1-152



DEC1-153

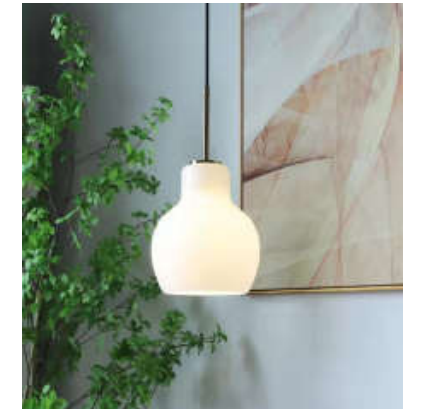

DEC1-154



DEC1-155



DEC1-156



DEC1-157



DEC1-158



DEC1-159



DEC1-160



DEC1-161



DEC1-162



DEC1-163



DEC1-164



DEC1-165



DEC1-166



DEC1-167



DEC1-168



DEC1-169



DEC1-170



DEC1-171



DEC1-172



DEC1-173



DEC1-174



DEC1-175



DEC1-176



DEC1-177

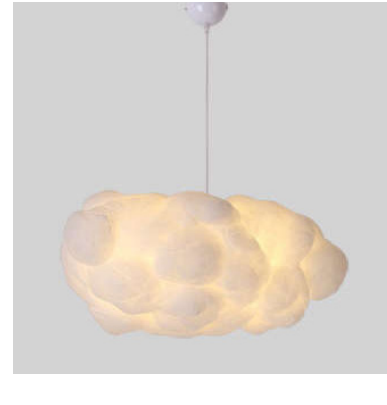

DEC1-178

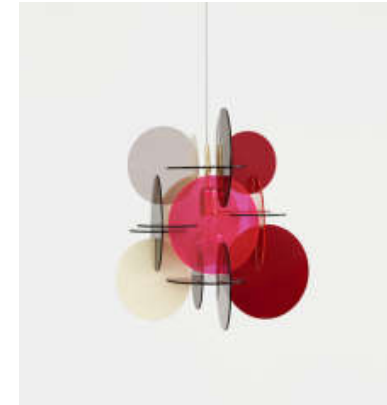

DEC1-179



DEC1-180



DEC1-181



DEC1-182



DEC1-183



DEC1-184



DEC1-185



DEC1-186



DEC1-187



DEC1-188



DEC1-189



DEC1-190



DEC1-191



DEC1-192



DEC1-193



DEC1-194



DEC1-195



DEC1-196



DEC1-197



DEC1-198



DEC1-199



DEC1-200



DEC1-201



DEC1-202



DEC1-203



DEC1-204



DEC1-205



DEC1-206



DEC1-207



DEC1-208



DEC1-209



DEC1-210



DEC1-211



DEC1-212



DEC1-213



DEC1-214



DEC1-215

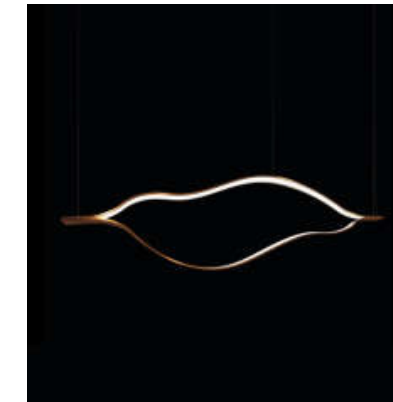

DEC1-216



DEC1-217



DEC1-218



DEC1-219



DEC1-220



DEC1-221



DEC1-222



DEC1-223



DEC1-224



DEC1-225



DEC1-226



DEC1-227



DEC1-228



DEC1-229



DEC1-230



DEC1-231



DEC1-232



DEC1-233



DEC1-234



DEC1-235



DEC1-236



DEC1-237



DEC1-238



DEC1-239



DEC1-240



DEC1-241



DEC1-242



DEC1-243



DEC1-244



DEC1-245



DEC1-246



DEC1-247



DEC1-248



DEC1-249



DEC1-250



DEC1-251



DEC1-252



DEC1-253



DEC1-254



DEC1-255

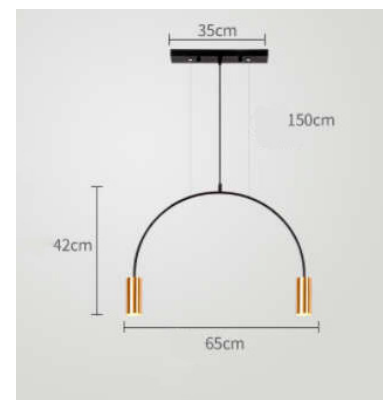

DEC1-256

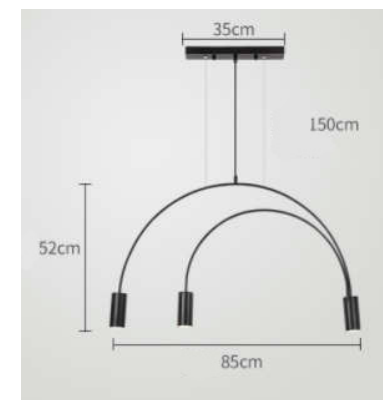

DEC1-257

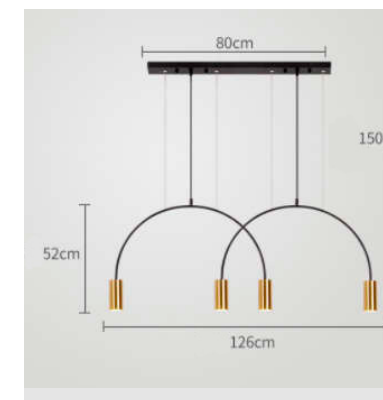

DEC1-258



DEC1-259

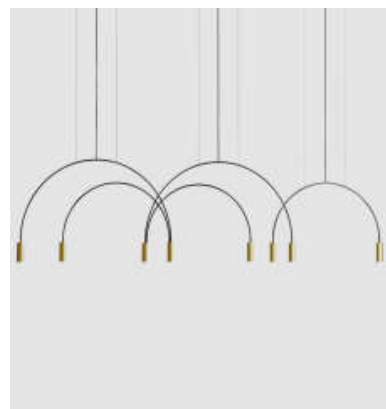

DEC1-260

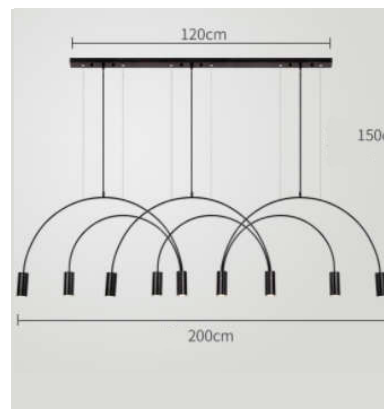

DEC1-261



DEC1-262



DEC1-263



DEC1-264



DEC1-265



DEC1-266



DEC1-267



DEC1-268



DEC1-269



DEC1-270

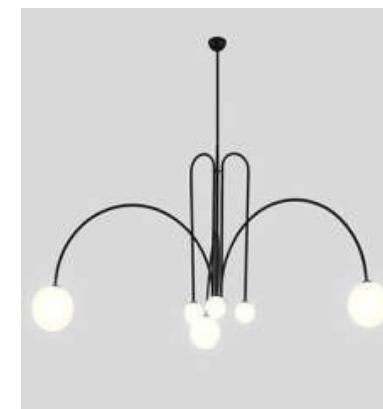

DEC1-271



DEC1-272



DEC1-273



DEC1-274



DEC1-275



DEC1-276



DEC1-277



DEC1-278



DEC1-279



DEC1-280



DEC1-281



DEC1-282



DEC1-283



DEC1-284



DEC1-285



DEC1-286



DEC1-287



DEC1-288



DEC1-289



DEC1-290



DEC1-291



DEC1-292



DEC1-293



DEC1-294



DEC1-295



DEC1-296



DEC1-297



DEC1-298



DEC1-299



DEC1-300



DEC1-301



DEC1-302



DEC1-303



DEC1-304



DEC1-305



DEC1-306



DEC1-307



DEC1-308



DEC1-309



DEC1-310

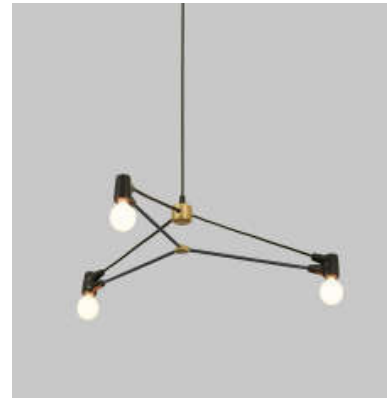

DEC1-311



DEC1-312



DEC1-313



DEC1-314



DEC1-315



DEC1-316



DEC1-317



DEC1-318



DEC1-319



DEC1-320



DEC1-321



DEC1-322



DEC1-323



DEC1-324



DEC1-325



DEC1-326



DEC1-327



DEC1-328



DEC1-329



DEC1-330



DEC1-331



DEC1-332



DEC1-333



DEC1-334



DEC1-335



DEC1-336



DEC1-337



DEC1-338



DEC1-339



DEC1-340



DEC1-341



DEC1-342



DEC1-343



DEC1-344



DEC1-345



DEC1-346



DEC1-347



DEC1-348



DEC1-349



DEC1-350



DEC1-351



DEC1-352



DEC1-353



DEC1-354



DEC1-355



DEC1-356



DEC1-357



DEC1-358



DEC1-359



DEC1-360



DEC1-361



DEC1-362



DEC1-636

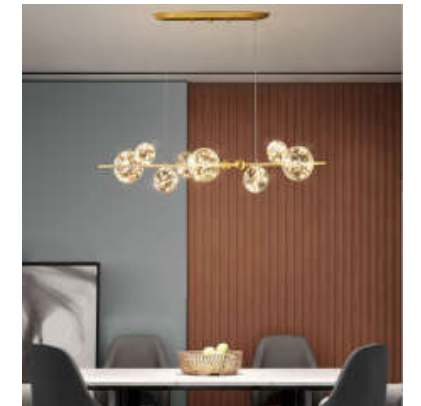

DEC1-364



DEC1-365



DEC1-366



DEC1-367



DEC1-368



DEC1-369



DEC1-370



DEC1-371



DEC1-372



DEC1-373



DEC1-374



DEC1-375

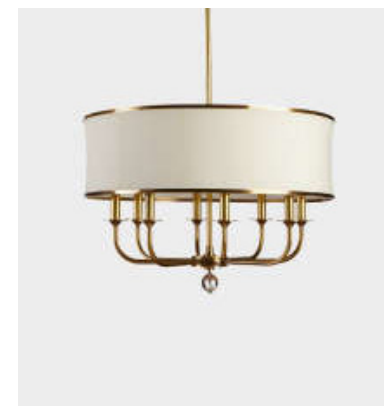

DEC1-376



DEC1-377



DEC1-378



DEC1-379



DEC1-380



DEC1-381



DEC1-382



DEC1-383



DEC1-384



DEC1-385



DEC1-386



DEC1-387



DEC1-388



DEC1-389



DEC1-390



DEC1-391



DEC1-392



DEC1-393



DEC1-394



DEC1-395



DEC1-396



DEC1-397



DEC1-398



DEC1-399



DEC1-400



DEC1-401

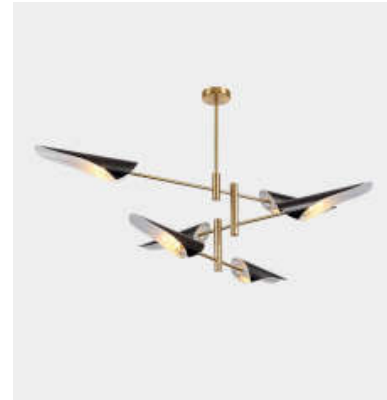

DEC1-402

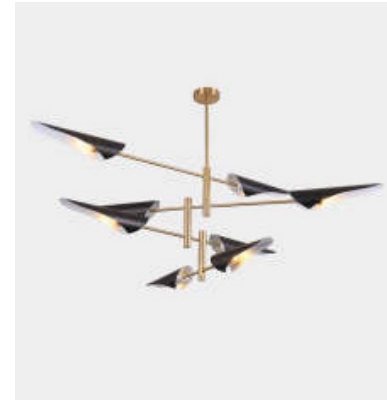

DEC1-403



DEC1-404



DEC1-405



DEC1-406



DEC1-407



DEC1-408



DEC1-409



DEC1-410



DEC1-411



DEC1-412



DEC1-413



DEC1-414



DEC1-415



DEC1-416



DEC1-417



DEC1-418



DEC1-419



DEC1-420



DEC1-421



DEC1-422



DEC1-423



DEC1-424



DEC1-425



DEC1-426



DEC1-427



DEC1-428



DEC1-429



DEC1-430



DEC1-431



DEC1-432



DEC1-433



DEC1-434

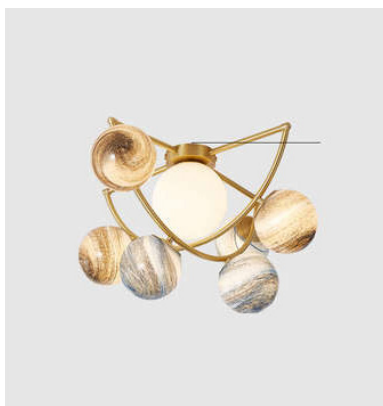

DEC1-435



DEC1-436



DEC1-437



DEC1-438



DEC1-439



DEC1-440



DEC1-441



DEC1-442



DEC1-443



DEC1-444



DEC1-445



DEC1-446



DEC1-447



DEC1-448



DEC1-449



DEC1-450



DEC1-451



DEC1-452



DEC1-453



DEC1-454



DEC1-455



DEC1-456



DEC1-457



DEC1-458



DEC1-459



DEC1-460



DEC1-461



DEC1-462



DEC1-463



DEC1-464



DEC1-465



DEC1-466



DEC1-467



DEC1-468



DEC1-469



DEC1-470



DEC1-471



DEC1-472



DEC1-473



DEC1-474



DEC1-475



DEC1-476



DEC1-477



DEC1-478



DEC1-479



DEC1-480



DEC1-481



DEC1-482



DEC1-483



DEC1-484



DEC1-485



DEC1-486



DEC1-487



DEC1-488



DEC1-489



DEC1-490



DEC1-491



DEC1-492



DEC1-493



DEC1-494



DEC1-495



DEC1-496



DEC1-497



DEC1-498



DEC1-499



DEC1-500



DEC1-501



DEC1-502

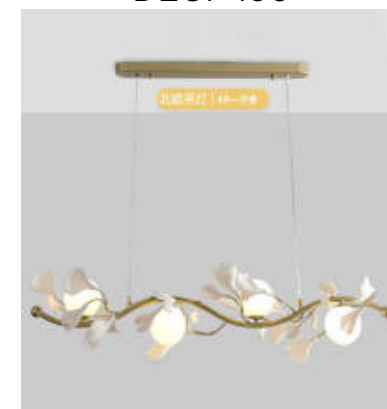

DEC1-503

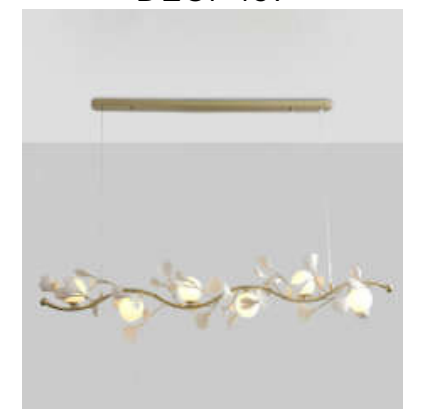

DEC1-504



DEC1-505



DEC1-506



DEC1-507



DEC1-508



DEC1-509



DEC1-510



DEC1-511



DEC1-512



DEC1-513



DEC1-514



DEC1-515



DEC1-516



DEC1-517



DEC1-518



DEC1-519



DEC1-520



DEC1-521



DEC1-522



DEC1-523



DEC1-524



DEC1-525



DEC1-526



DEC1-527



DEC1-528



DEC1-529



DEC1-530



DEC1-531



DEC1-532



DEC1-533



DEC1-534



DEC1-535



DEC1-536



DEC1-537



DEC1-538



DEC1-539



DEC1-540



DEC1-541



DEC1-542



DEC1-543



DEC1-544



DEC1-545



DEC1-546



DEC1-547



DEC1-548



DEC1-549



DEC1-550



DEC1-551



DEC1-552



DEC1-553



DEC1-554



DEC1-555



DEC1-556



DEC1-557



DEC1-558

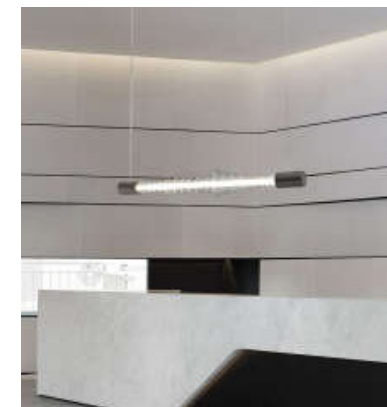

DEC1-559



DEC1-560



DEC1-561



DEC1-562

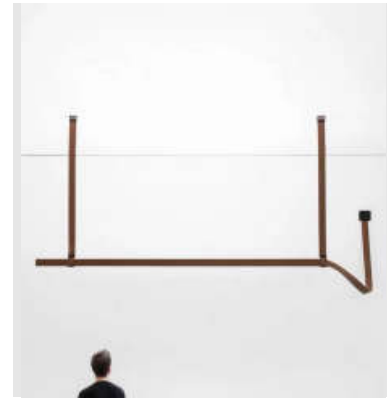

DEC1-563



DEC1-564



DEC1-565



DEC1-566



DEC1-567



DEC1-568



DEC1-569



DEC1-570



DEC1-571



DEC1-572

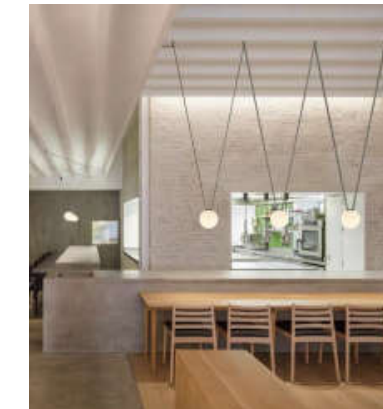

DEC1-573

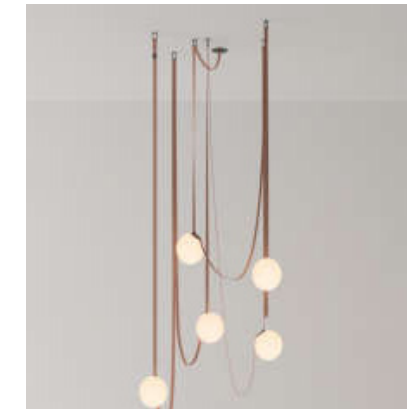

DEC1-574



DEC1-575



DEC1-576



DEC1-577



DEC1-578



DEC1-579



DEC1-580



DEC1-581



DEC1-582



DEC1-583

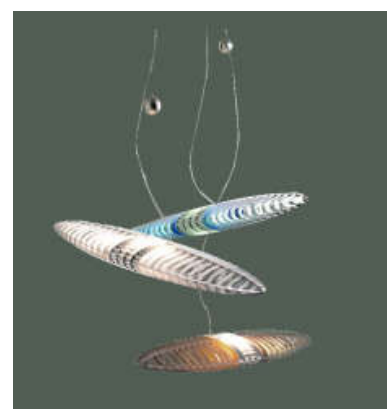

DEC1-584



DEC1-585



DEC1-586



DEC1-587



DEC1-588



DEC1-589



DEC1-590



DEC1-591



DEC1-592



DEC1-593



DEC1-594



DEC1-595



DEC1-596



DEC1-597



DEC1-598



DEC1-599



DEC1-600



DEC1-601



DEC1-602



DEC1-603



DEC1-604



DEC1-605



DEC1-606



DEC1-607



DEC1-608



DEC1-609



DEC1-610



DEC1-611



DEC1-612

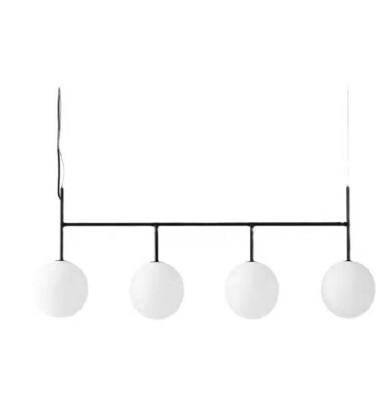

DEC1-613



DEC1-614



DEC1-615



DEC1-616



DEC1-617

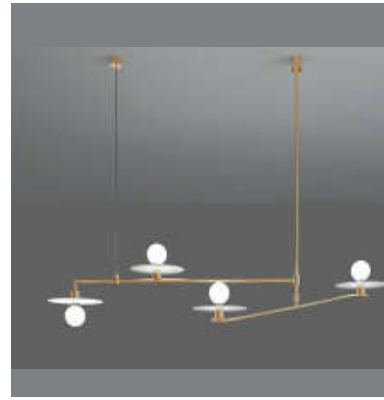

DEC1-618



DEC1-619



DEC1-620



DEC1-621

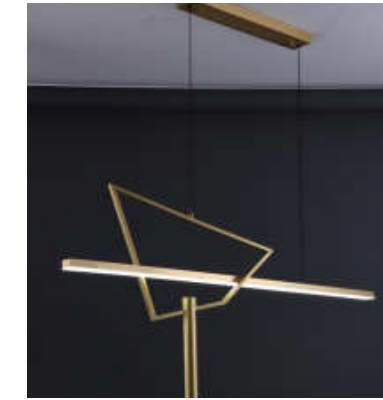

DEC1-622



DEC1-623



DEC1-624



DEC1-625



DEC1-626



DEC1-627



DEC1-628



DEC1-629



DEC1-630



DEC1-631



DEC1-632



DEC1-633



DEC1-634



DEC1-635



DEC1-636



DEC1-637



DEC1-638



DEC1-639



DEC1-640



DEC1-641



DEC1-642



DEC1-643



DEC1-644



DEC1-645



DEC1-646



DEC1-647



DEC1-648



DEC1-649



DEC1-650



DEC1-651



DEC1-652



DEC1-653



DEC1-654



DEC1-655



DEC1-656



DEC1-657



DEC1-658



DEC1-659



DEC1-660



DEC1-661



DEC1-662



DEC1-663



DEC1-664

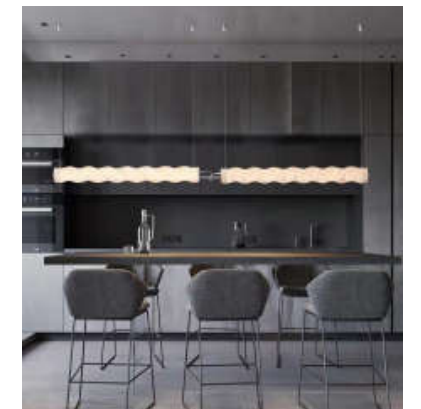

DEC1-665



DEC1-666



DEC1-667

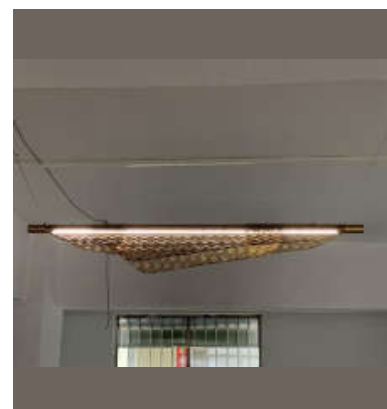

DEC1-668



DEC1-669



DEC1-670



DEC1-671



DEC1-672



DEC1-673



DEC1-674



DEC1-675



DEC1-676

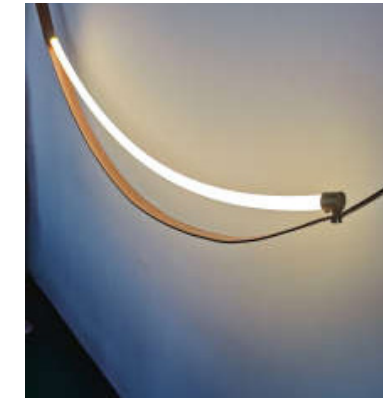

DEC1-677



DEC1-678



DEC1-679



DEC1-680



DEC1-681



DEC1-682



DEC1-683



DEC1-684



DEC1-685



DEC1-686



DEC1-687



DEC1-688



DEC1-689



DEC1-690



DEC1-691



DEC1-692



DEC1-693



DEC1-694



DEC1-695



DEC1-696

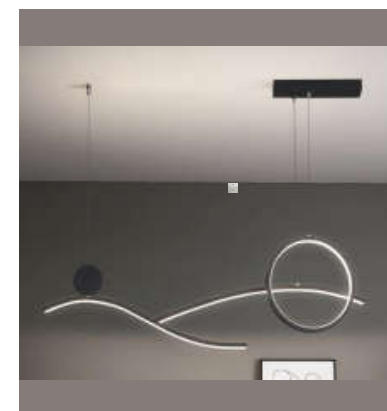

DEC1-697

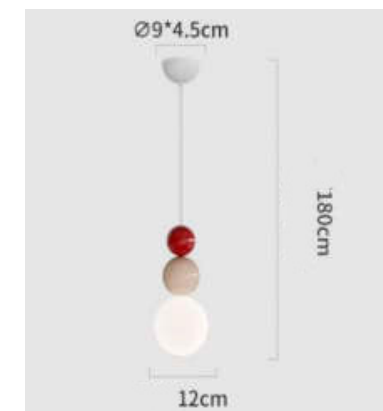

DEC1-698



DEC1-699



DEC1-700



DEC1-701



DEC1-702



DEC1-703



DEC1-704



DEC1-705



DEC1-706



DEC1-707



DEC1-708



DEC1-709



DEC1-710



DEC1-711



DEC1-712



DEC1-713



DEC1-714



DEC1-715

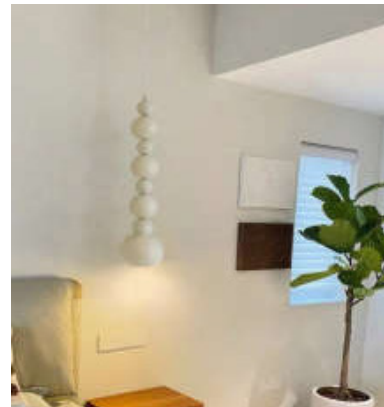

DEC1-716



DEC1-717



DEC1-718



DEC1-719



DEC1-720



DEC1-721



DEC1-722



DEC1-723



DEC1-724



DEC1-725



DEC1-726



DEC1-727



DEC1-728



DEC1-729



DEC1-730



DEC1-731



DEC1-732



DEC1-733



DEC1-734



DEC1-735



DEC1-736



DEC1-737



DEC1-738



DEC1-739



DEC1-740



DEC1-741



DEC1-742



DEC1-743



DEC1-744



DEC1-745



DEC1-746



DEC1-747



DEC1-748



DEC1-749



DEC1-750



DEC1-751



DEC1-752



DEC1-753



DEC1-754



DEC1-755



DEC1-756



DEC1-757



DEC1-758



DEC1-759



DEC1-760



DEC1-761



DEC1-762



DEC1-763



DEC1-764



DEC1-765



DEC1-766



DEC1-767



DEC1-768



DEC1-769



DEC1-770



DEC1-771



DEC1-772



DEC1-773



DEC1-774



DEC1-775



DEC1-776



DEC1-777



DEC1-778



DEC1-779



DEC1-780



DEC1-781



DEC1-782



DEC1-783



DEC1-784



DEC1-785



DEC1-786



DEC1-787



DEC1-788



DEC1-789



DEC1-790



DEC1-791



DEC1-792



DEC1-793



DEC1-794



DEC1-795



DEC1-796



DEC1-797



DEC1-798



DEC1-799



DEC1-800



DEC1-801



DEC1-802



DEC1-803



DEC1-804



DEC1-805



DEC1-806



DEC1-807



DEC1-808



DEC1-809



DEC1-810



DEC1-811



DEC1-812



DEC1-813



DEC1-814



DEC1-815



DEC1-816



DEC1-817



DEC1-818



DEC1-819



DEC1-820



DEC1-821



DEC1-822



DEC1-823



DEC1-824



DEC1-825



DEC1-826



DEC1-827



DEC1-828



DEC1-829



DEC1-830



DEC1-831



DEC1-832



DEC1-833



DEC1-834



DEC1-835



DEC1-836



DEC1-837



DEC1-838



DEC1-839



DEC1-840



DEC1-841



DEC1-842



DEC1-843



DEC1-844



DEC1-845



DEC1-846



DEC1-847



DEC1-848



DEC1-849



DEC1-850



DEC1-851



DEC1-852



DEC1-853



DEC1-854



DEC1-855



DEC1-856



DEC1-857



DEC1-858



DEC1-859



DEC1-860



DEC1-861



DEC1-862



DEC1-863



DEC1-864



DEC1-865



DEC1-866



DEC1-867



DEC1-868



DEC1-869



DEC1-870



DEC1-871

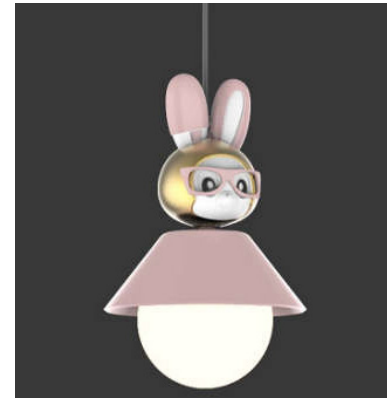

DEC1-872

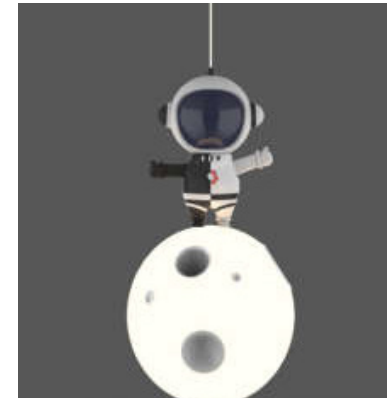

DEC1-873



DEC1-874



DEC1-875



DEC1-876



DEC1-877



DEC1-878



DEC1-879



DEC1-880



DEC1-881



DEC1-882



DEC1-883



DEC1-884



DEC1-885



DEC1-886



DEC1-887



DEC1-888



DEC1-889



DEC1-890



DEC1-891



DEC1-892



DEC1-893



DEC1-894



DEC1-895



DEC1-896



DEC1-897



DEC1-898



DEC1-899



DEC1-900



DEC1-901



DEC1-902



DEC1-903



DEC1-904



DEC1-905



DEC1-906

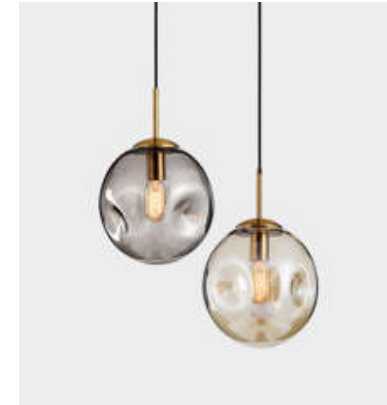

DEC1-907



DEC1-908



DEC1-909



DEC1-910



DEC1-911



DEC1-912



DEC1-913



DEC1-914



DEC1-915



DEC1-916



DEC1-917



DEC1-918



DEC1-919



DEC1-920



DEC1-921



DEC1-922



DEC1-923



DEC1-924



DEC1-925



DEC1-926



DEC1-927



DEC1-928



DEC1-929



DEC1-930



DEC1-931



DEC1-932



DEC1-933



DEC1-934



DEC1-935



DEC1-936



DEC1-937



DEC1-938



DEC1-939



DEC1-940



DEC1-941



DEC1-942



DEC1-943



DEC1-944



DEC1-945



DEC1-946



DEC1-947



DEC1-948



DEC1-949



DEC1-950



DEC1-951



DEC1-952



DEC1-953



DEC1-954



DEC1-955



DEC1-956



DEC1-957



DEC1-958



DEC1-959



DEC1-960



DEC1-961



DEC1-962



DEC1-963



DEC1-964



DEC1-965



DEC1-966



DEC1-967



DEC1-968



DEC1-969



DEC1-970



DEC1-971



DEC1-972



DEC1-973



DEC1-974

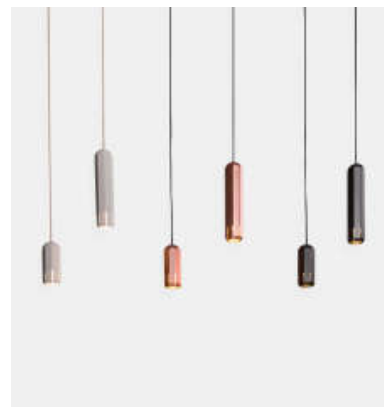

DEC1-975



DEC1-976



DEC1-977



DEC1-978

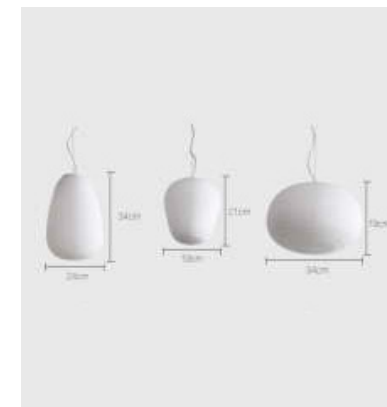

DEC1-979



DEC1-980



DEC1-981



DEC1-982



DEC1-983



DEC1-984



DEC1-985



DEC1-986



DEC1-987



DEC1-988



DEC1-989



DEC1-990



DEC1-991



DEC1-992



DEC1-993



DEC1-994



DEC1-995



DEC1-996



DEC1-997



DEC1-998



DEC1-999



DEC1-1000



DEC1-1001



DEC1-1002



DEC1-1003



DEC1-1004



DEC1-1005



DEC1-1006



DEC1-1007



DEC1-1008



DEC1-1009



DEC1-1010



DEC1-1011



DEC1-1012



DEC1-1013



DEC1-1014



DEC1-1015



DEC1-1016



DEC1-1017



DEC1-1018



DEC1-1019



DEC1-1020



DEC1-1021



DEC1-1022



DEC1-1023



DEC1-1024



DEC1-1025



DEC1-1026



DEC1-1027



DEC1-1028



DEC1-1029



DEC1-1030

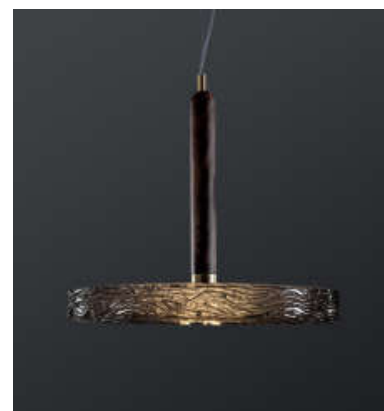

DEC1-1031

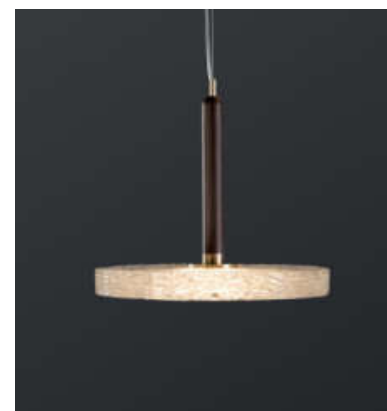

DEC1-1032



DEC1-1033



DEC1-1034



DEC1-1035



DEC1-1036



DEC1-1037



DEC1-1038



DEC1-1039



DEC1-1040



DEC1-1041



DEC1-1042



DEC1-1043



DEC1-1044



DEC1-1045



DEC1-1046



DEC1-1047



DEC1-1048



DEC1-1049



DEC1-1050



DEC1-1051



DEC1-1052



DEC1-1053



DEC1-1054



DEC1-1055



DEC1-1056

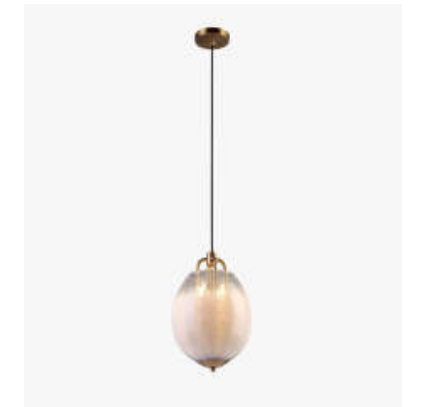

DEC1-1057



DEC1-1058



DEC1-1059



DEC1-1060



DEC1-1061



DEC1-1062



DEC1-1063



DEC1-1064



DEC1-1065



DEC1-1066



DEC1-1067



DEC1-1068



DEC1-1069



DEC1-1070



DEC1-1071



DEC1-1072



DEC1-1073



DEC1-1074



DEC1-1075



DEC1-1076



DEC1-1077



DEC1-1078

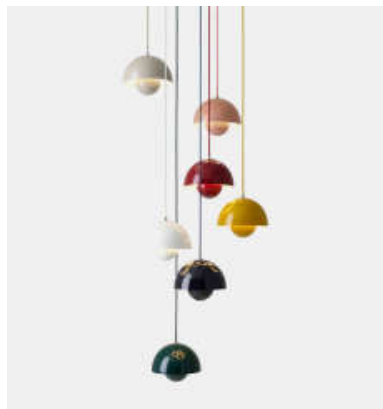

DEC1-1079



DEC1-1080



DEC1-1081



DEC1-1082



DEC1-1083



DEC1-1084



DEC1-1085



DEC1-1086



DEC1-1087



DEC1-1088



DEC1-1089



DEC1-1090



DEC1-1091



DEC1-1092



DEC1-1093



DEC1-1094



DEC1-1095



DEC1-1096



DEC1-1097



DEC1-1098



DEC1-1099



DEC1-1100



DEC1-1101



DEC1-1102



DEC1-1103



DEC1-1104



DEC1-1105



DEC1-1106



DEC1-1107



DEC1-1108



DEC1-1109



DEC1-1110



DEC1-1111



DEC1-1112



DEC1-1113



DEC1-1114



DEC1-1115



DEC1-1116



DEC1-1117



DEC1-1118



DEC1-1119



DEC1-1120



DEC1-1121



DEC1-1122



DEC1-1123



DEC1-1124



DEC1-1125



DEC1-1126



DEC1-1127



DEC1-1128



DEC1-1129



DEC1-1130



DEC1-1131



DEC1-1132



DEC1-1133



DEC1-1134



DEC1-1135



DEC1-1136



DEC1-1137



DEC1-1138



DEC1-1139



DEC1-1140



DEC1-1141



DEC1-1142



DEC1-1143



DEC1-1144



DEC1-1145



DEC1-1146



DEC1-1147



DEC1-1148



DEC1-1149



DEC1-1150



DEC1-1151



DEC1-1152

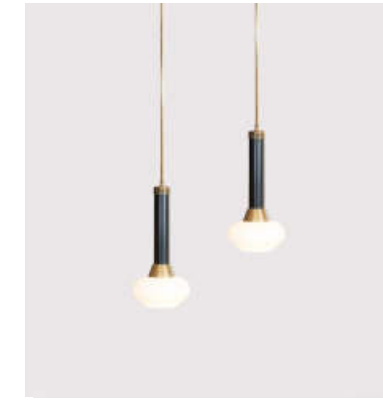

DEC1-1153



DEC1-1154



DEC1-1155



DEC1-1156



DEC1-1157



DEC1-1158



DEC1-1159



DEC1-1160



DEC1-1161



DEC1-1162



DEC1-1163



DEC1-1164



DEC1-1165



DEC1-1166



DEC1-1167



DEC1-1168



DEC1-1169



DEC1-1170



DEC1-1171



DEC1-1172



DEC1-1173



DEC1-1174



DEC1-1175



DEC1-1176



DEC1-1177



DEC1-1178



DEC1-1179



DEC1-1180



DEC1-1181



DEC1-1182



DEC1-1183



DEC1-1184



DEC1-1185



DEC1-1186



DEC1-1187



DEC1-1188



DEC1-1189



DEC1-1190



DEC1-1191



DEC1-1192



DEC1-1193



DEC1-1194



DEC1-1195



DEC1-1196



DEC1-1197



DEC1-1198



DEC1-1199



DEC1-1200



DEC1-1201



DEC1-1202



DEC1-1203



DEC1-1204



DEC1-1205



DEC1-1206



DEC1-1207



DEC1-1208



DEC1-1209



DEC1-1210



DEC1-1211



DEC1-1212



DEC1-1213



DEC1-1214



DEC1-1215



DEC1-1216



DEC1-1217



DEC1-1218



DEC1-1219



DEC1-1220



DEC1-1221



DEC1-1222



DEC1-1223



DEC1-1224



DEC1-1225



DEC1-1226



DEC1-1227



DEC1-1228



DEC1-1229



DEC1-1230



DEC1-1231



DEC1-1232



DEC1-1233



DEC1-1234



DEC1-1235



DEC1-1236



DEC1-1237



DEC1-1238



DEC1-1239



DEC1-1240



DEC1-1241



DEC1-1242



DEC1-1243



DEC1-1244



DEC1-1245



DEC1-1246



DEC1-1247



DEC1-1248



DEC1-1249



DEC1-1250



DEC1-1251



DEC1-1252



DEC1-1253



DEC1-1254



DEC1-1255



DEC1-1256



DEC1-1257



DEC1-1258



DEC1-1259



DEC1-1260



DEC1-1261



DEC1-1262



DEC1-1263



DEC1-1264



DEC1-1265



DEC1-1266



DEC1-1267



DEC1-1268



DEC1-1269

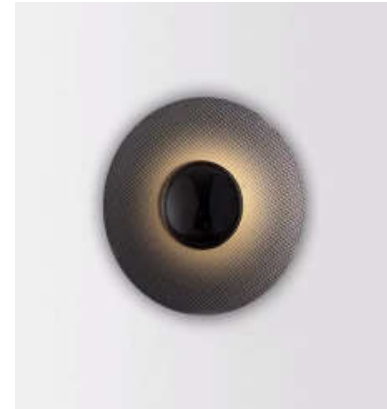

DEC1-1270



DEC1-1271



DEC1-1272



DEC1-1273

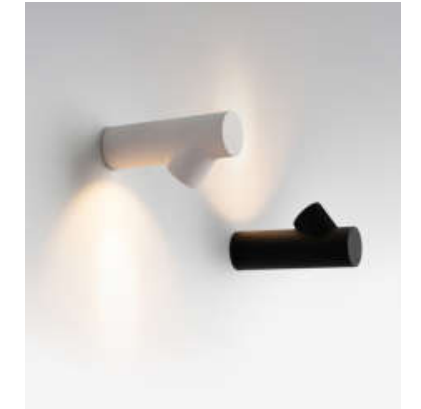

DEC1-1274



DEC1-1275



DEC1-1276



DEC1-1277



DEC1-1278



DEC1-1279



DEC1-1280



DEC1-1281



DEC1-1282



DEC1-1283



DEC1-1284



DEC1-1285



DEC1-1286



DEC1-1287



DEC1-1288



DEC1-1289



DEC1-1290



DEC1-1291



DEC1-1292



DEC1-1293



DEC1-1294



DEC1-1295



DEC1-1296



DEC1-1297



DEC1-1298



DEC1-1299



DEC1-1300



DEC1-1301



DEC1-1302



DEC1-1303



DEC1-1304



DEC1-1305



DEC1-1306



DEC1-1307



DEC1-1308

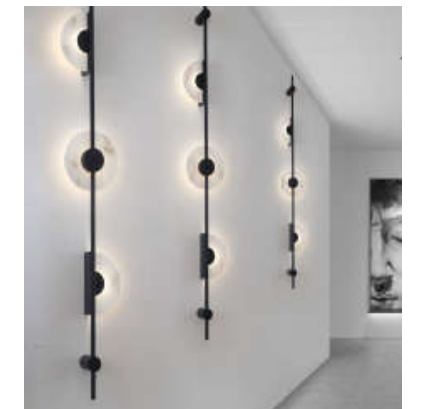

DEC1-1309

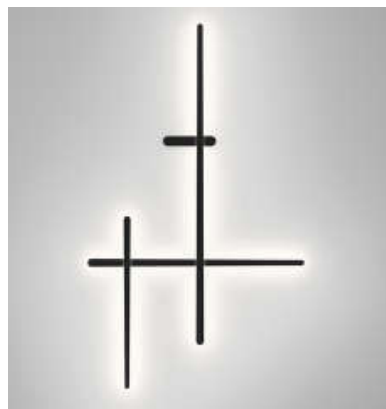

DEC1-1310



DEC1-1311



DEC1-1312



DEC1-1313



DEC1-1314



DEC1-1315



DEC1-1316



DEC1-1317



DEC1-1318



DEC1-1319



DEC1-1320



DEC1-1321



DEC1-1322



DEC1-1323



DEC1-1324

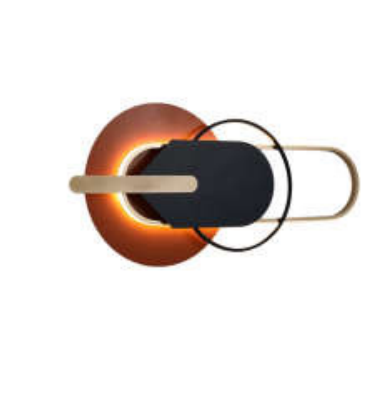

DEC1-1325



DEC1-1326



DEC1-1327



DEC1-1328



DEC1-1329



DEC1-1330



DEC1-1331



DEC1-1332



DEC1-1333



DEC1-1334



DEC1-1335

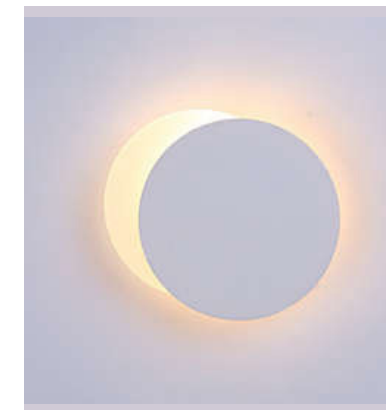

DEC1-1336



DEC1-1337



DEC1-1338



DEC1-1339



DEC1-1340



DEC1-1341



DEC1-1342



DEC1-1343



DEC1-1344



DEC1-1345

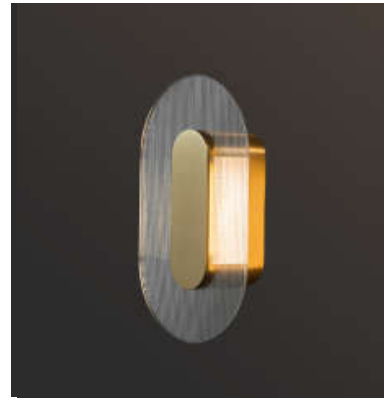

DEC1-1346

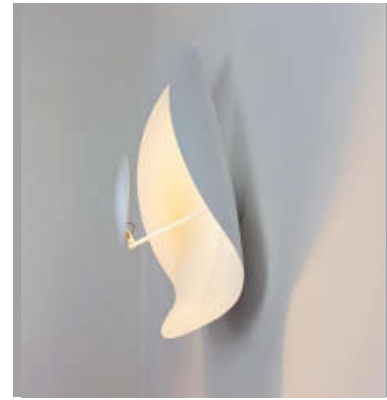

DEC1-1347



DEC1-1348



DEC1-1349



DEC1-1350



DEC1-1351



DEC1-1352



DEC1-1353



DEC1-1354



DEC1-1355



DEC1-1356



DEC1-1357



DEC1-1358



DEC1-1359



DEC1-1360



DEC1-1361



DEC1-1362



DEC1-1363



DEC1-1364



DEC1-1365



DEC1-1366



DEC1-1367



DEC1-1368



DEC1-1369



DEC1-1370



DEC1-1371

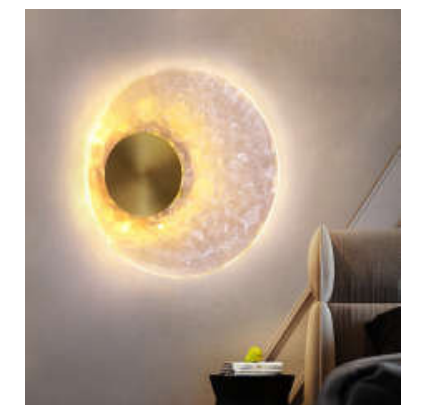

DEC1-1372



DEC1-1373



DEC1-1374



DEC1-1375

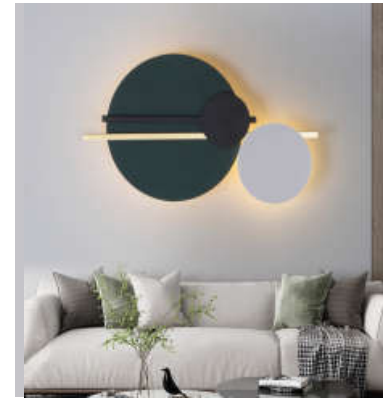

DEC1-1376



DEC1-1377



DEC1-1378



DEC1-1379



DEC1-1380



DEC1-1381

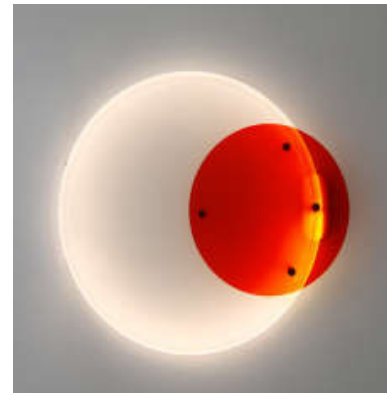

DEC1-1382



DEC1-1383



DEC1-1384



DEC1-1385



DEC1-1386



DEC1-1387



DEC1-1388



DEC1-1389



DEC1-1390



DEC1-1391



DEC1-1392



DEC1-1393



DEC1-1394



DEC1-1395



DEC1-1396



DEC1-1397



DEC1-1398



DEC1-1399



DEC1-1400



DEC1-1401



DEC1-1402



DEC1-1403



DEC1-1404

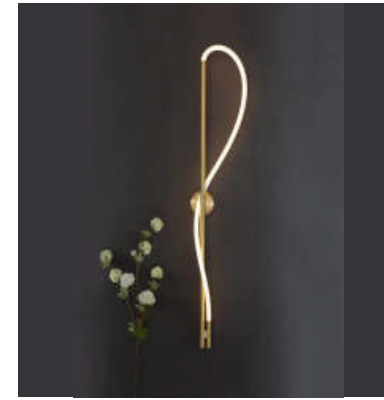

DEC1-1405



DEC1-1406



DEC1-1407



DEC1-1408



DEC1-1409



DEC1-1410



DEC1-1411



DEC1-1412



DEC1-1413

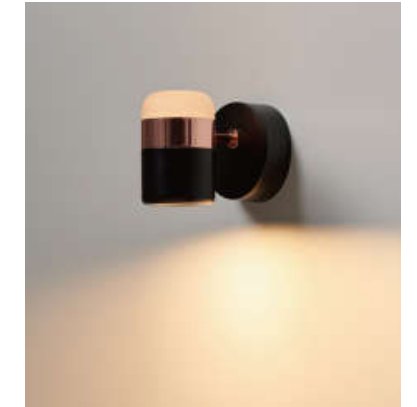

DEC1-1414



DEC1-1415



DEC1-1416



DEC1-1417



DEC1-1418



DEC1-1419



DEC1-1420



DEC1-1421



DEC1-1422



DEC1-1423



DEC1-1424



DEC1-1425



DEC1-1426



DEC1-1427



DEC1-1428



DEC1-1429

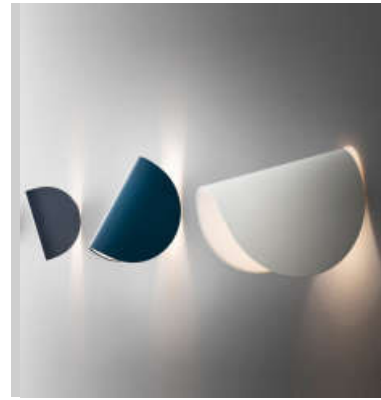

DEC1-1430



DEC1-1431



DEC1-1432



DEC1-1433



DEC1-1434



DEC1-1435



DEC1-1436



DEC1-1437



DEC1-1438



DEC1-1439



DEC1-1440



DEC1-1441



DEC1-1442



DEC1-1443



DEC1-1444



DEC1-1445



DEC1-1446



DEC1-1447



DEC1-1448



DEC1-1449



DEC1-1450

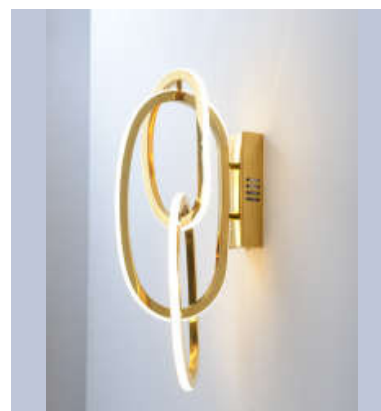

DEC1-1451



DEC1-1452



DEC1-1453



DEC1-1454



DEC1-1455



DEC1-1456



DEC1-1457



DEC1-1458



DEC1-1459



DEC1-1460



DEC1-1461



DEC1-1462



DEC1-1463



DEC1-1464



DEC1-1465



DEC1-1466



DEC1-1467



DEC1-1468

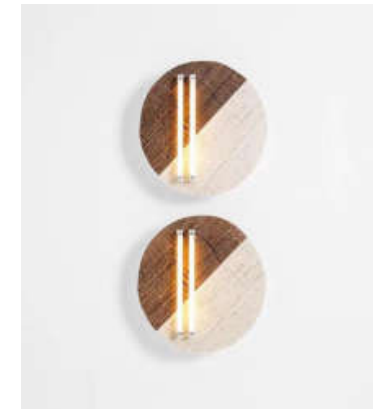

DEC1-1469



DEC1-1470



DEC1-1471



DEC1-1472



DEC1-1473



DEC1-1474



DEC1-1475



DEC1-1476



DEC1-1477



DEC1-1478



DEC1-1479



DEC1-1480



DEC1-1481



DEC1-1482



DEC1-1483

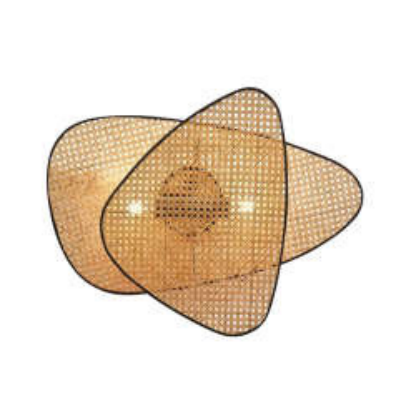

DEC1-1484



DEC1-1485



DEC1-1486



DEC1-1487



DEC1-1488



DEC1-1489



DEC1-1490



DEC1-1491



DEC1-1492



DEC1-1493



DEC1-1494



DEC1-1495



DEC1-1496



DEC1-1497



DEC1-1498



DEC1-1499



DEC1-1500



DEC1-1501



DEC1-1502



DEC1-1503



DEC1-1504



DEC1-1505



DEC1-1506



DEC1-1507



DEC1-1508



DEC1-1509



DEC1-1510



DEC1-1511

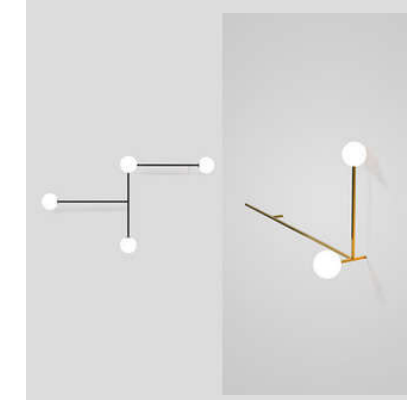

DEC1-1512



DEC1-1513

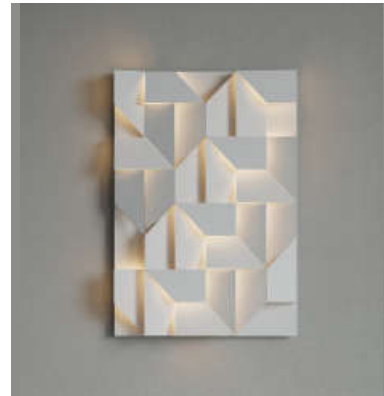

DEC1-1514



DEC1-1515



DEC1-1516



DEC1-1517



DEC1-1518



DEC1-1519



DEC1-1520



DEC1-1521



DEC1-1522



DEC1-1523



DEC1-1524



DEC1-1525



DEC1-1526



DEC1-1527



DEC1-1528



DEC1-1529



DEC1-1530



DEC1-1531



DEC1-1532



DEC1-1533



DEC1-1534



DEC1-1535



DEC1-1536



DEC1-1537



DEC1-1538



DEC1-1539



DEC1-1540



DEC1-1541



DEC1-1542



DEC1-1543



DEC1-1544



DEC1-1545



DEC1-1546



DEC1-1547



DEC1-1548



DEC1-1549



DEC1-1550



DEC1-1551



DEC1-1552



DEC1-1553



DEC1-1554



DEC1-1555

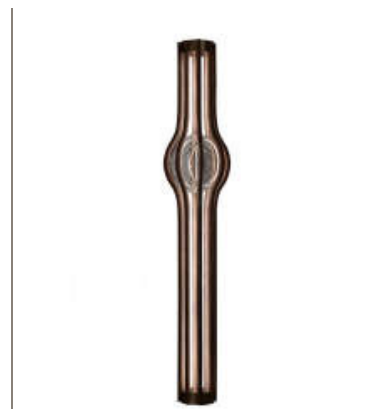

DEC1-1556



DEC1-1557

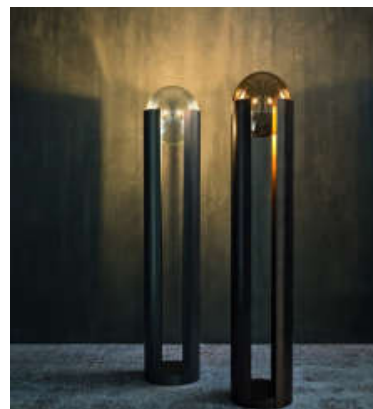

DEC1-1558



DEC1-1559



DEC1-1560



DEC1-1561



DEC1-1562



DEC1-1563



DEC1-1564



DEC1-1565



DEC1-1566



DEC1-1567



DEC1-1568



DEC1-1569



DEC1-1570



DEC1-1571



DEC1-1572



DEC1-1573



DEC1-1574



DEC1-1575



DEC1-1576



DEC1-1577



DEC1-1578



DEC1-1579



DEC1-1580



DEC1-1581



DEC1-1582



DEC1-1583



DEC1-1584

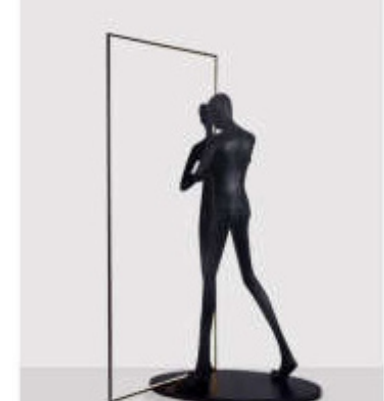

DEC1-1585



DEC1-1586



DEC1-1587



DEC1-1588



DEC1-1589



DEC1-1590



DEC1-1591



DEC1-1592



DEC1-1593



DEC1-1594



DEC1-1595



DEC1-1596



DEC1-1597



DEC1-1598



DEC1-1599



DEC1-1600



DEC1-1601



DEC1-1602



DEC1-1603



DEC1-1604



DEC1-1605



DEC1-1606



DEC1-1607



DEC1-1608



DEC1-1609



DEC1-1610



DEC1-1611



DEC1-1612



DEC1-1613



DEC1-1614



DEC1-1615



DEC1-1616



DEC1-1617



DEC1-1618



DEC1-1619



DEC1-1620



DEC1-1621



DEC1-1622



DEC1-1623



DEC1-1624



DEC1-1625



DEC1-1626



DEC1-1627



DEC1-1628



DEC1-1629



DEC1-1630



DEC1-1631



DEC1-1632



DEC1-1633



DEC1-1634



DEC1-1635



DEC1-1636



DEC1-1637



DEC1-1638



DEC1-1639

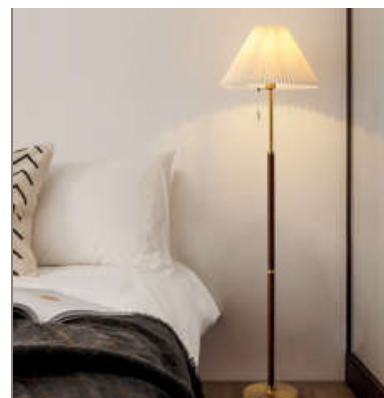

DEC1-1640

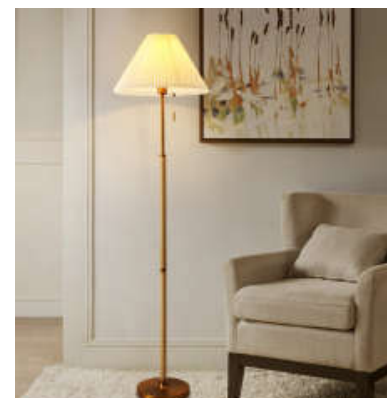

DEC1-1641



DEC1-1642



DEC1-1643



DEC1-1644



DEC1-1645



DEC1-1646



DEC1-1647

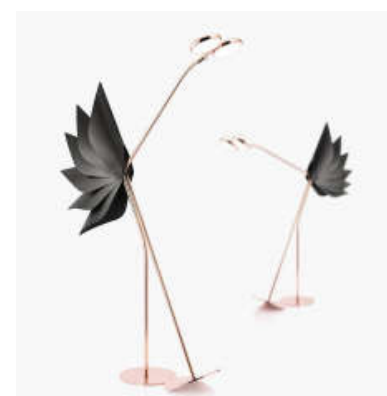

DEC1-1648



DEC1-1649



DEC1-1650



DEC1-1651



DEC1-1652



DEC1-1653



DEC1-1654



DEC1-1655



DEC1-1656



DEC1-1657



DEC1-1658



DEC1-1659



DEC1-1660



DEC1-1661



DEC1-1662



DEC1-1663



DEC1-1664



DEC1-1665



DEC1-1666



DEC1-1667



DEC1-1668



DEC1-1669



DEC1-1670



DEC1-1671



DEC1-1672



DEC1-1673



DEC1-1674



DEC1-1675



DEC1-1676



DEC1-1677



DEC1-1678



DEC1-1679

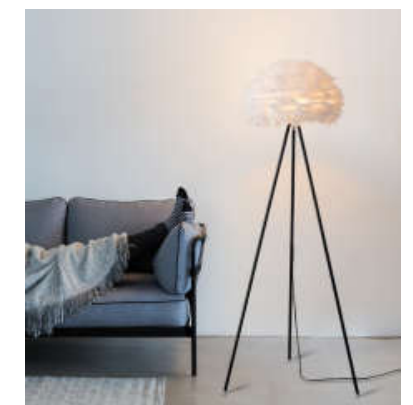

DEC1-1680



DEC1-1681



DEC1-1682



DEC1-1683



DEC1-1684



DEC1-1685



DEC1-1686



DEC1-1687



DEC1-1688



DEC1-1689



DEC1-1690



DEC1-1691



DEC1-1692



DEC1-1693



DEC1-1694



DEC1-1695



DEC1-1696



DEC1-1697



DEC1-1698



DEC1-1699



DEC1-1700



DEC1-1701



DEC1-1702



DEC1-1703



DEC1-1704



DEC1-1705



DEC1-1706



DEC1-1707



DEC1-1708



DEC1-1709

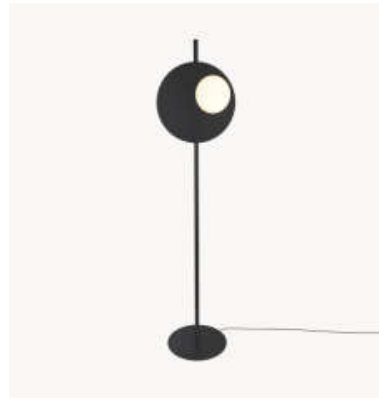

DEC1-1710



DEC1-1711



DEC1-1712



DEC1-1713



DEC1-1714



DEC1-1715



DEC1-1716



DEC1-1717



DEC1-1718



DEC1-1719



DEC1-1720



DEC1-1721



DEC1-1722



DEC1-1723



DEC1-1724



DEC1-1725



DEC1-1726



DEC1-1727



DEC1-1728



DEC1-1729



DEC1-1730



DEC1-1731



DEC1-1732



DEC1-1733



DEC1-1734



DEC1-1735



DEC1-1736



DEC1-1737

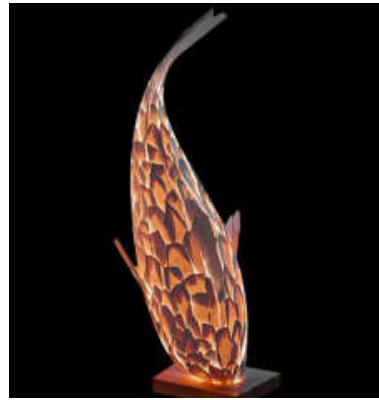

DEC1-1738



DEC1-1739



DEC1-1740



DEC1-1741



DEC1-1742



DEC1-1743



DEC1-1744



DEC1-1745



DEC1-1746



DEC1-1747



DEC1-1748



DEC1-1749



DEC1-1750



DEC1-1751



DEC1-1752



DEC1-1753



DEC1-1754



DEC1-1755



DEC1-1756



DEC1-1757



DEC1-1758



DEC1-1759



DEC1-1760



DEC1-1761



DEC1-1762



DEC1-1763



DEC1-1764



DEC1-1765



DEC1-1766



DEC1-1767

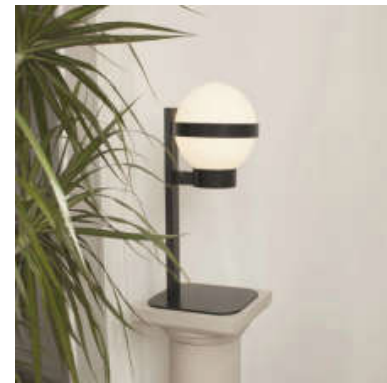

DEC1-1768



DEC1-1769



DEC1-1770



DEC1-1771



DEC1-1772



DEC1-1773



DEC1-1774



DEC1-1775



DEC1-1776



DEC1-1777



DEC1-1778



DEC1-1779



DEC1-1780



DEC1-1781



DEC1-1782



DEC1-1783



DEC1-1784



DEC1-1785



DEC1-1786



DEC1-1787



DEC1-1788



DEC1-1789



DEC1-1790



DEC1-1791



DEC1-1792



DEC1-1793



DEC1-1794



DEC1-1795



DEC1-1796



DEC1-1797



DEC1-1798



DEC1-1799



DEC1-1800

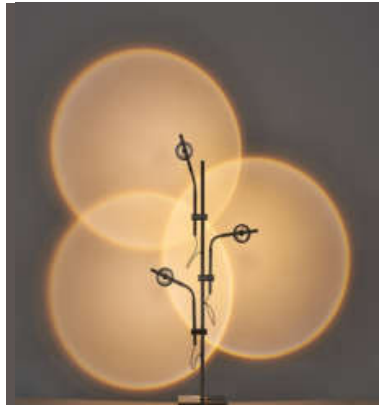

DEC1-1801



DEC1-1802



DEC1-1803



DEC1-1804



DEC1-1805



DEC1-1806



DEC1-1807



DEC1-1808



DEC1-1809



DEC1-1810



DEC1-1811



DEC1-1812



DEC1-1813



DEC1-1814



DEC1-1815



DEC1-1816



DEC1-1817



DEC1-1818



DEC1-1819

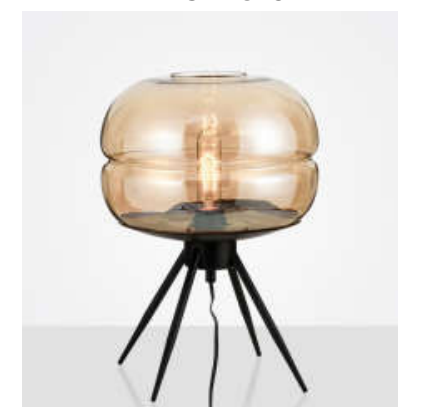

DEC1-1820

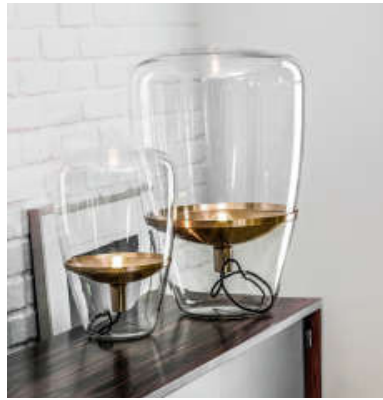

DEC1-1821



DEC1-1822



DEC1-1823



DEC1-1824



DEC1-1825



DEC1-1826

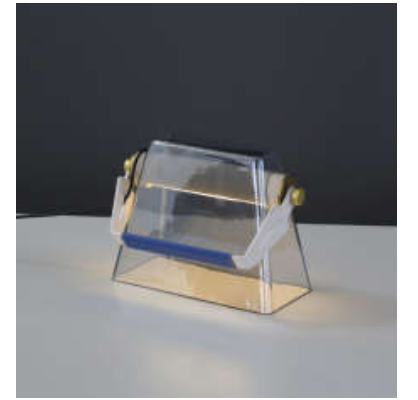

DEC1-1827



DEC1-1828

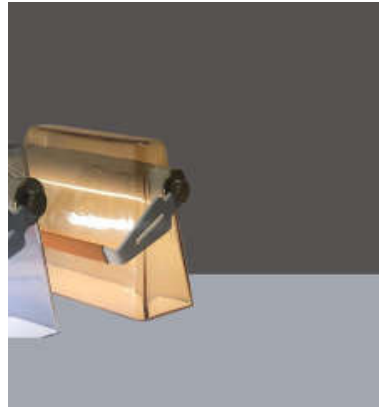

DEC1-1829



DEC1-1830



DEC1-1831



DEC1-1832



DEC1-1833



DEC1-1834



DEC1-1835



DEC1-1836



DEC1-1837



DEC1-1838



DEC1-1839



DEC1-1840



DEC1-1841



DEC1-1842



DEC1-1843



DEC1-1844



DEC1-1845



DEC1-1846



DEC1-1847



DEC1-1848



DEC1-1849



DEC1-1850



DEC1-1851



DEC1-1852



DEC1-1853



DEC1-1854



DEC1-1855



DEC1-1856



DEC1-1857



DEC1-1858



DEC1-1859



DEC1-1860



DEC1-1861



DEC1-1862



DEC1-1863



DEC1-1864



DEC1-1865



DEC1-1866



DEC1-1867



DEC1-1868



DEC1-1869



DEC1-1870



DEC1-1871



DEC1-1872



DEC1-1873



DEC1-1874



DEC1-1875



DEC1-1876



DEC1-1877



DEC1-1878



DEC1-1879



DEC1-1880



DEC1-1881



DEC1-1882



DEC1-1883



DEC1-1884



DEC1-1885



DEC1-1886



DEC1-1887



DEC1-1888



DEC1-1889



DEC1-1890



DEC1-1891



DEC1-1892



DEC1-1893



DEC1-1894



DEC1-1895



DEC1-1896



DEC1-1897



DEC1-1898



DEC1-1899



DEC1-1900



DEC1-1901



DEC1-1902



DEC1-1903



DEC1-1904



DEC1-1905



DEC1-1906



DEC1-1907



DEC1-1908



DEC1-1909



DEC1-1910



DEC1-1911



DEC1-1912



DEC1-1913



DEC1-1914



DEC1-1915



DEC1-1916



DEC1-1917



DEC1-1918



DEC1-1919



DEC1-1920



DEC1-1921



DEC1-1922



DEC1-1923



DEC1-1924



DEC1-1925



DEC1-1926



DEC1-1927



DEC1-1928



DEC1-1929



DEC1-1930



DEC1-1931



DEC1-1932



DEC1-1933



DEC1-1934



DEC1-1935



DEC1-1936



DEC1-1937



DEC1-1938



DEC1-1939



DEC1-1940

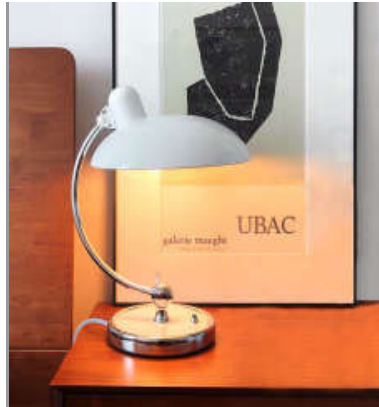

DEC1-1941



DEC1-1942



DEC1-1943



DEC1-1944



DEC1-1945



DEC1-1946



DEC1-1947



DEC1-1948



DEC1-1949



DEC1-1950



DEC1-1951



DEC1-1952



DEC1-1953



DEC1-1954



DEC1-1955



DEC1-1956



DEC1-1957



DEC1-1958



DEC1-1959



DEC1-1960



DEC1-1961



DEC1-1962

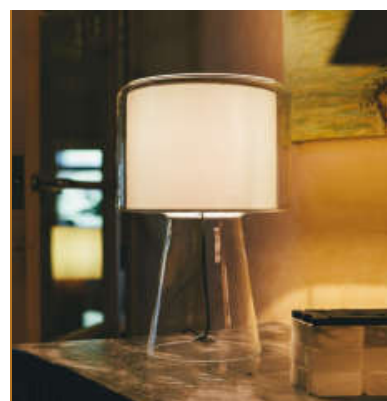

DEC1-1963



DEC1-1964



DEC1-1965



DEC1-1966



DEC1-1967



DEC1-1968



DEC1-1969



DEC1-1970



DEC1-1971



DEC1-1972



DEC1-1973



DEC1-1974



DEC1-1975



DEC1-1976



DEC1-1977



DEC1-1978



DEC1-1979



DEC1-1980



DEC1-1981



DEC1-1981



DEC1-1982



DEC1-1983



DEC1-1984



DEC1-1985



DEC1-1986



DEC1-1987



DEC1-1988



DEC1-1989



DEC1-1990

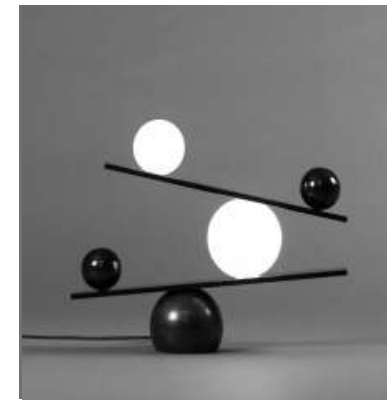

DEC1-1991



DEC1-1991



DEC1-1993



DEC1-1994



DEC1-1995



DEC1-1996



DEC1-1997



DEC1-1998



DEC1-1999



DEC1-2000



DEC1-2001



DEC1-2002



DEC1-2003



DEC1-2004



DEC1-2005



DEC1-2006



DEC1-2007



DEC1-2008



DEC1-2009



DEC1-2010



DEC1-2011

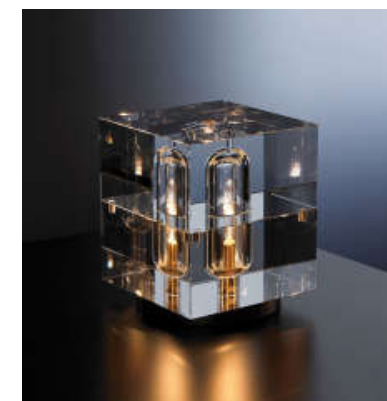

DEC1-2012



DEC1-2013



DEC1-2014



DEC1-2015



DEC1-2016



DEC1-2017



DEC1-2018



DEC1-2019



DEC1-2020



DEC1-2021



DEC1-2022



DEC1-2023



DEC1-2024



DEC1-2025



DEC1-2026



DEC1-2027



DEC1-2028



DEC1-2029



DEC1-2030



DEC1-2031



DEC1-2032



DEC1-2033



DEC1-2034



DEC1-2035

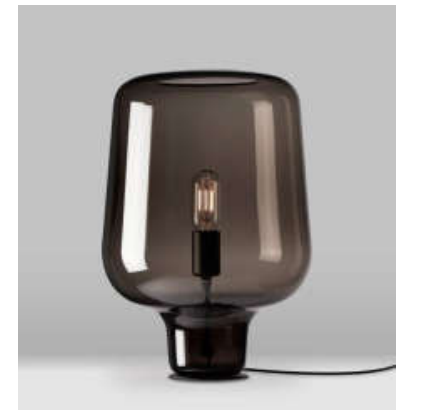

DEC1-2036



DEC1-2037



DEC1-2038



DEC1-2039



DEC1-2040



DEC1-2041



DEC1-2042



DEC1-2043



DEC1-2044



DEC1-2045



DEC1-2046



DEC1-2047



DEC1-2048



DEC1-2049



DEC1-2050



DEC1-2051



DEC1-2052



DEC1-2053



DEC1-2054



DEC1-2055



DEC1-2056



DEC1-2057



DEC1-2058

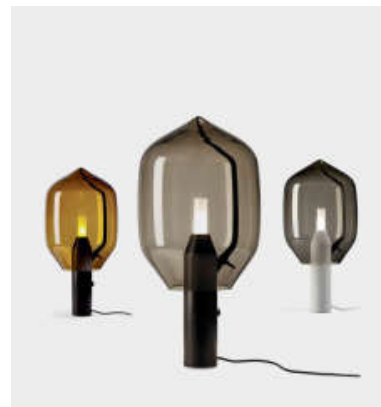

DEC1-2059



DEC1-2060



DEC1-2061



DEC1-2062



DEC1-2063



DEC1-2064



DEC1-2065



DEC1-2066



DEC1-2067



DEC1-2068



DEC1-2069



DEC1-2070



DEC1-2071



DEC1-2072



DEC1-2073



DEC1-2074



DEC1-2075



DEC1-2076



DEC1-2077



DEC1-2078



DEC1-2079



DEC1-2080



DEC1-2081

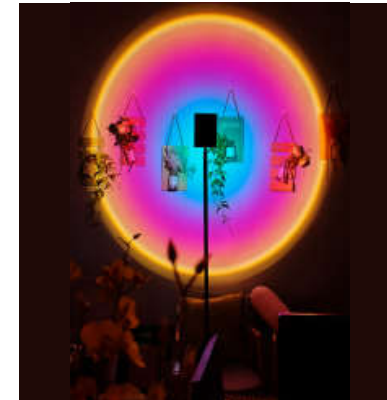

DEC1-2082

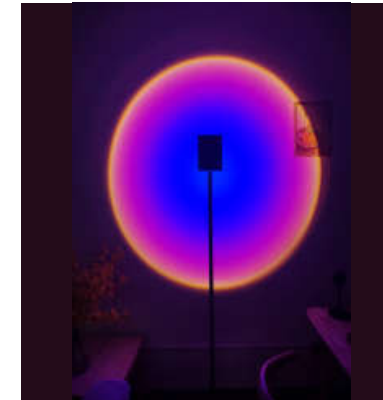

DEC1-2083

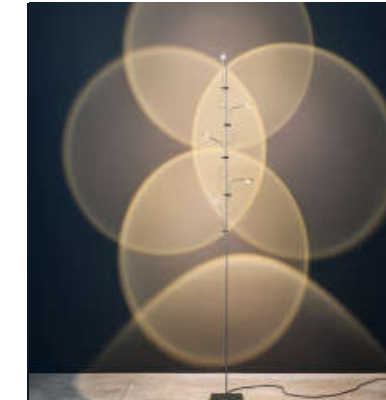

DEC1-2084



DEC1-2085



DEC1-2086



DEC1-2087



DEC1-2088



DEC1-2089



DEC1-2090



DEC1-2091



DEC1-2092



DEC1-2093



DEC1-2094



DEC1-2095



DEC1-2096



DEC1-2097



DEC1-2098



DEC1-2099



DEC1-2100



DEC1-2101



DEC1-2102



DEC1-2103



DEC1-2104



DEC1-2105



DEC1-2106



DEC1-2107



DEC1-2108



DEC1-2109



DEC1-2110



DEC1-2111



DEC1-2112



DEC1-2113



DEC1-2114



DEC1-2115



DEC1-2116



DEC1-2117



DEC1-2118



DEC1-2119



DEC1-2120



DEC1-2121



DEC1-2122



DEC1-2123



DEC1-2124



DEC1-2125



DEC1-2126



DEC1-2127



DEC1-2128



DEC1-2129



DEC1-2130



DEC1-2131



DEC1-2132



DEC1-2133



DEC1-2134



DEC1-2135



DEC1-2136



DEC1-2137



DEC1-21138



DEC1-2139



DEC1-2140



DEC1-2141



DEC1-2142



DEC1-2143



DEC1-2144



DEC1-2145



DEC1-2146



DEC1-2147



DEC1-2148



DEC1-2149



DEC1-2150



DEC1-2151

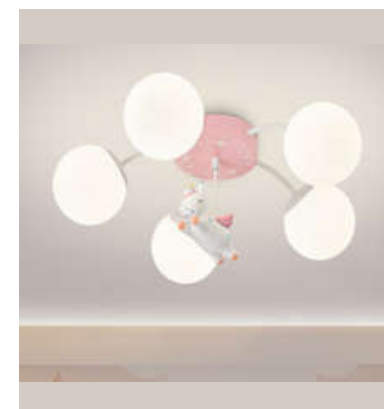

DEC1-2152



DEC1-2153



DEC1-2154



DEC1-2155



DEC1-2156



DEC1-2157



DEC1-2158



DEC1-2159



DEC1-2160



DEC1-2161



DEC1-2162



DEC1-2163



DEC1-2164



DEC1-2165



DEC1-2166



DEC1-2167



DEC1-2168



DEC1-2169



DEC1-2170



DEC1-2171



DEC1-2172



DEC1-2173



DEC1-2174



DEC1-2175



DEC1-2176



DEC1-2177



DEC1-2178



DEC1-2179



DEC1-2180



DEC1-2181



DEC1-2182



DEC1-2183



DEC1-2184



DEC1-2185



DEC1-2186



DEC1-2187



DEC1-2188

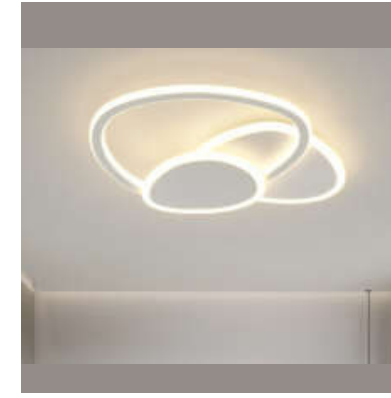

DEC1-2189



DEC1-2190



DEC1-2191



DEC1-2192



DEC1-2193



DEC1-2194



DEC1-2195



DEC1-2196



DEC1-2197



DEC1-2198



DEC1-2199



DEC1-2200



DEC1-2201



DEC1-2202



DEC1-2203

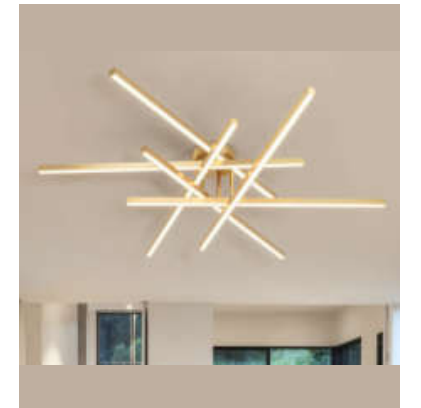

DEC1-2204



DEC1-2205



DEC1-2206



DEC1-2207



DEC1-2208



DEC1-2209



DEC1-2210



DEC1-2211



DEC1-2212



DEC1-2213



DEC1-2214



DEC1-2215



DEC1-2216



DEC1-2217



DEC1-2218



DEC1-2219



DEC1-2220



DEC1-2221



DEC1-2222



DEC1-2223



DEC1-2224



DEC1-2225



DEC1-2226



DEC1-2227



DEC1-2228



DEC1-2229



DEC1-2230



DEC1-2231



DEC1-2232



DEC1-2233



DEC1-2234



DEC1-2235



DEC1-2236



DEC1-2237



DEC1-2238



DEC1-2239



DEC1-2240



DEC1-2241



DEC1-2242



DEC1-2243



DEC1-2244



DEC1-2245



DEC1-2246



DEC1-2247



DEC1-2248



DEC1-2249



DEC1-2250



DEC1-2251



DEC1-2252



DEC1-2253



DEC1-2254



DEC1-2255

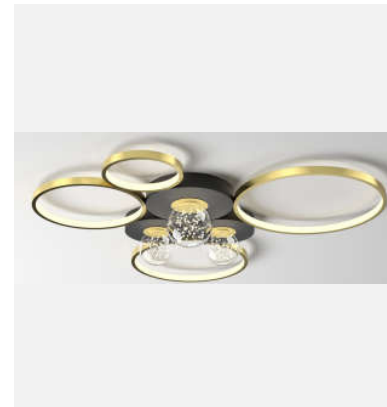

DEC1-2256



DEC1-2257



DEC1-2258



DEC1-2259



DEC1-2260



DEC1-2261



DEC1-2262



DEC1-2263



DEC1-2264



DEC1-2265



DEC1-2266



DEC1-2267



DEC1-2268



DEC1-2269



DEC1-2270



DEC1-2271



DEC1-2272



DEC1-2273



DEC1-2274



DEC1-2275



DEC1-2276



DEC1-2277



DEC1-2278



DEC1-2279



DEC1-2280



DEC1-2281



DEC1-2282



DEC1-2283



DEC1-2284



DEC1-2285



DEC1-2286



DEC1-2287



DEC1-2288



DEC1-2289



DEC1-2290



DEC1-2291



DEC1-2292



DEC1-2293



DEC1-2294



DEC1-2295



DEC1-2296



DEC1-2297



DEC1-2298



DEC1-2299



DEC1-2300



DEC1-2301



DEC1-2302



DEC1-2303



DEC1-2304



DEC1-2305



DEC1-2306



DEC1-2307

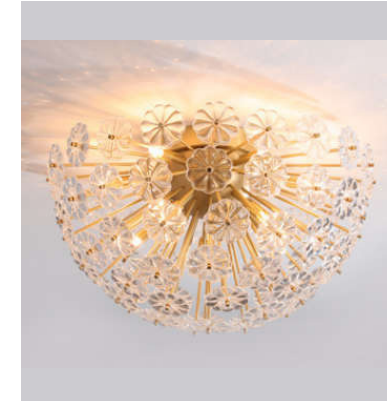

DEC1-2308



DEC1-2309



DEC1-2310



DEC1-2311



DEC1-2312



DEC1-2313



DEC1-2314



DEC1-2315



DEC1-2316



DEC1-2317



DEC1-2318



DEC1-2319



DEC1-2320



DEC1-2321



DEC1-2322

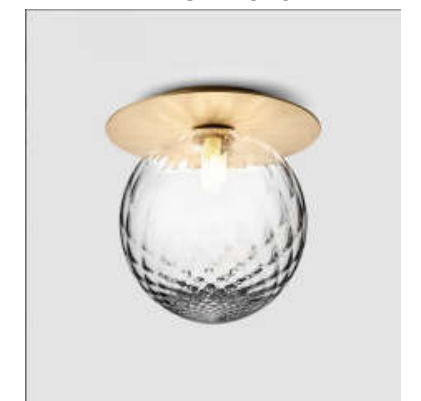

DEC1-2323



DEC1-2324



DEC1-2325



DEC1-2326



DEC1-2327



DEC1-2328



DEC1-2329



DEC1-2330



DEC1-2331



DEC1-2332



DEC1-2333



DEC1-2334



DEC1-2335



DEC1-2336

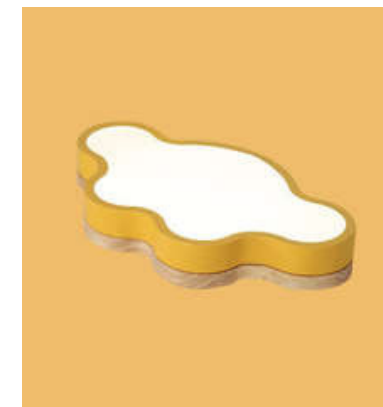

DEC1-2337



DEC1-2338

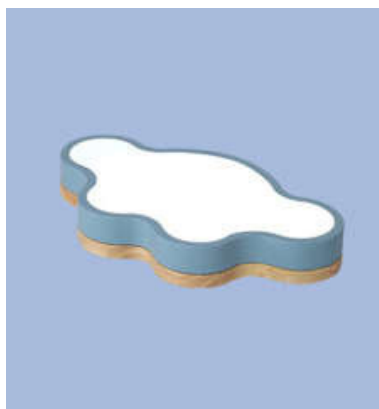

DEC1-2339



DEC1-2340



DEC1-2341



DEC1-2342



DEC1-2343



DEC1-2344



DEC1-2345



DEC1-2346



DEC1-2347



DEC1-2348



DEC1-2349



DEC1-2350



DEC1-2351



DEC1-2352



DEC1-2353



DEC1-2354



DEC1-2355



DEC1-2356



DEC1-2357



DEC1-2358



DEC1-2359



DEC1-2360



DEC1-2361



DEC1-2362



DEC1-2363



DEC1-2364



DEC1-2365



DEC1-2366



DEC1-2367



DEC1-2368



DEC1-2369



DEC1-2370



DEC1-2371



DEC1-2372



DEC1-2373



DEC1-2374



DEC1-2375



DEC1-2376



DEC1-2377

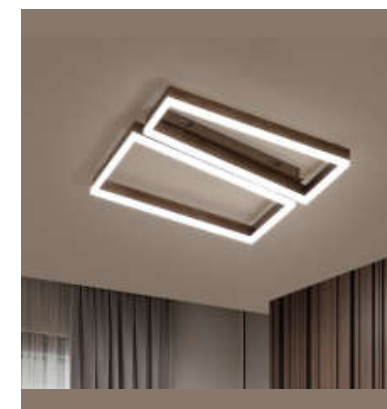

DEC1-2378



DEC1-2379



DEC1-2380



DEC1-2381



DEC1-2382



DEC1-2383



DEC1-2384



DEC1-2385



DEC1-2386



DEC1-2387



DEC1-2388

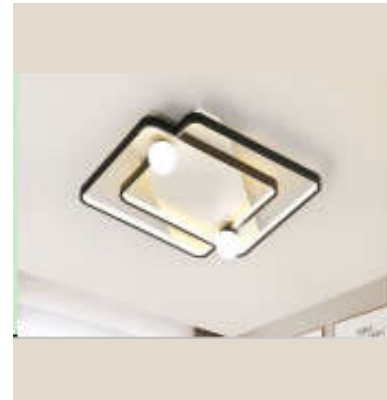

DEC1-2389



DEC1-2390



DEC1-2391



DEC1-2392



DEC1-2393



DEC1-2394



DEC1-2395



DEC1-2396



DEC1-2397



DEC1-2398

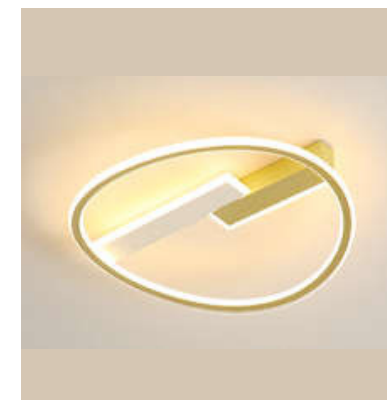

DEC1-2399



DEC1-2400

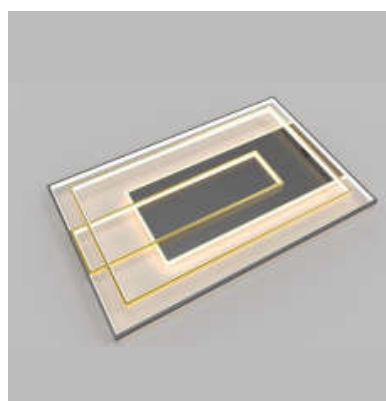

DEC1-2401

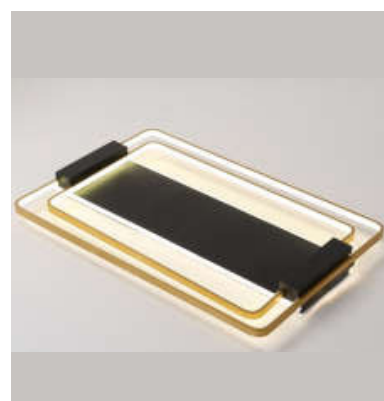

DEC1-2402



DEC1-2403



DEC1-2404

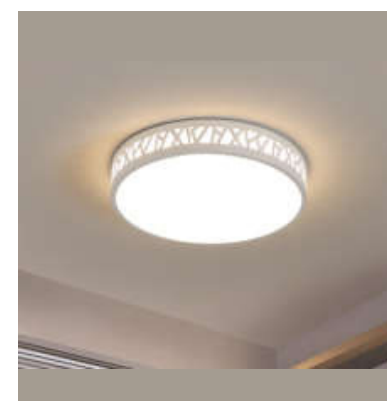

DEC1-2405



DEC1-2406

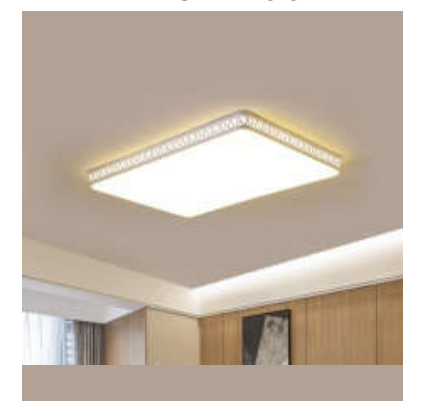

DEC1-2407



DEC1-2408



DEC1-2409



DEC1-2410



DEC1-2411



DEC1-2412



DEC1-2413



DEC1-2414



DEC1-2415



DEC1-2416



DEC1-2417



DEC1-2418



DEC1-2419



DEC1-2420



DEC1-2421



DEC1-2422



DEC1-2423



DEC1-2424



DEC1-2425



DEC1-2426



DEC1-2427



DEC1-2428



DEC1-2429



DEC1-2430

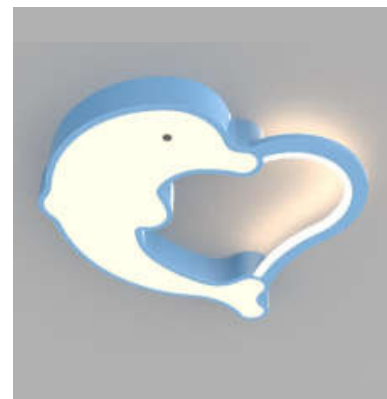

DEC1-2431

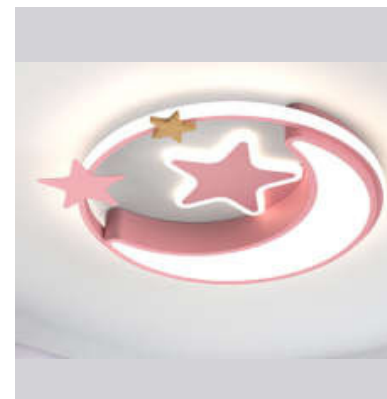

DEC1-2432



DEC1-2433



DEC1-2434



DEC1-2435



DEC1-2436



DEC1-2437



DEC1-2438



DEC1-2439



DEC1-2440



DEC1-2441



DEC1-2442

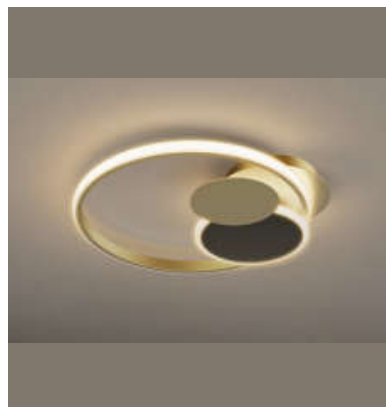

DEC1-2443



DEC1-2444



DEC1-2445



DEC1-2446



DEC1-2447



DEC1-2448



DEC1-2449



DEC1-2450



DEC1-2451



DEC1-2452



DEC1-2453



DEC1-2454



DEC1-2455



DEC1-2456



DEC1-2457



DEC1-2458



DEC1-2459



DEC1-2460



DEC1-2461



DEC1-2462



DEC1-2463



DEC1-2464



DEC1-2465



DEC1-2466



DEC1-2467



DEC1-2468



DEC1-2469



DEC1-2470



DEC1-2471



DEC1-2472



DEC1-2473



DEC1-2474

H Lux^{MR}